

Metal Wardrobe

Owner's Manual/
Instruction for Assembly Model:452.103

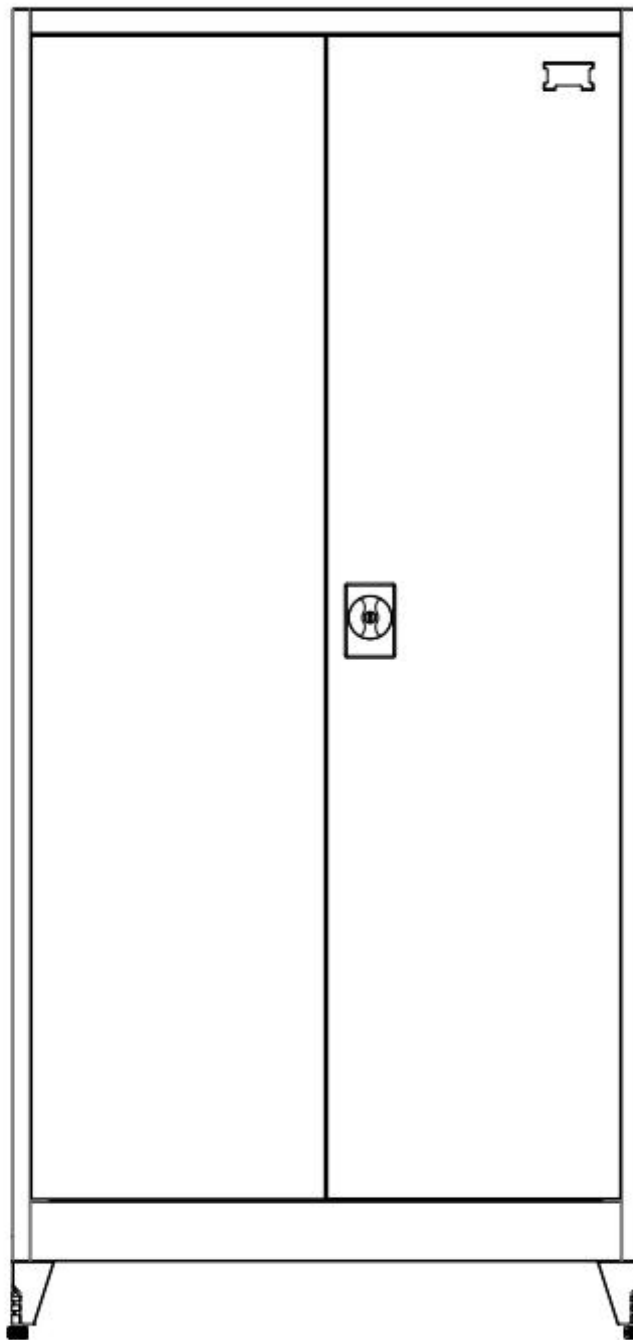

Size of Model:452.103

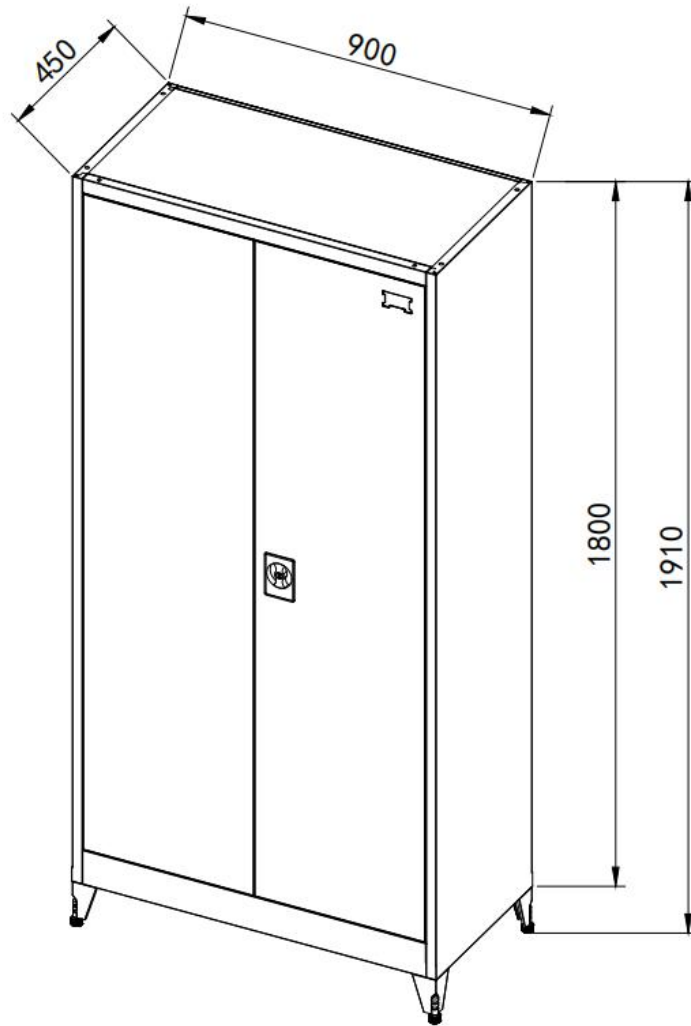

Area of installation requirement:

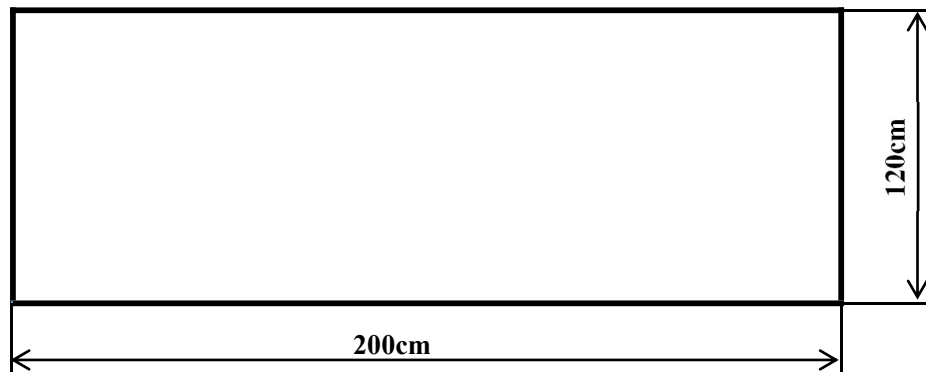

Explosive View:

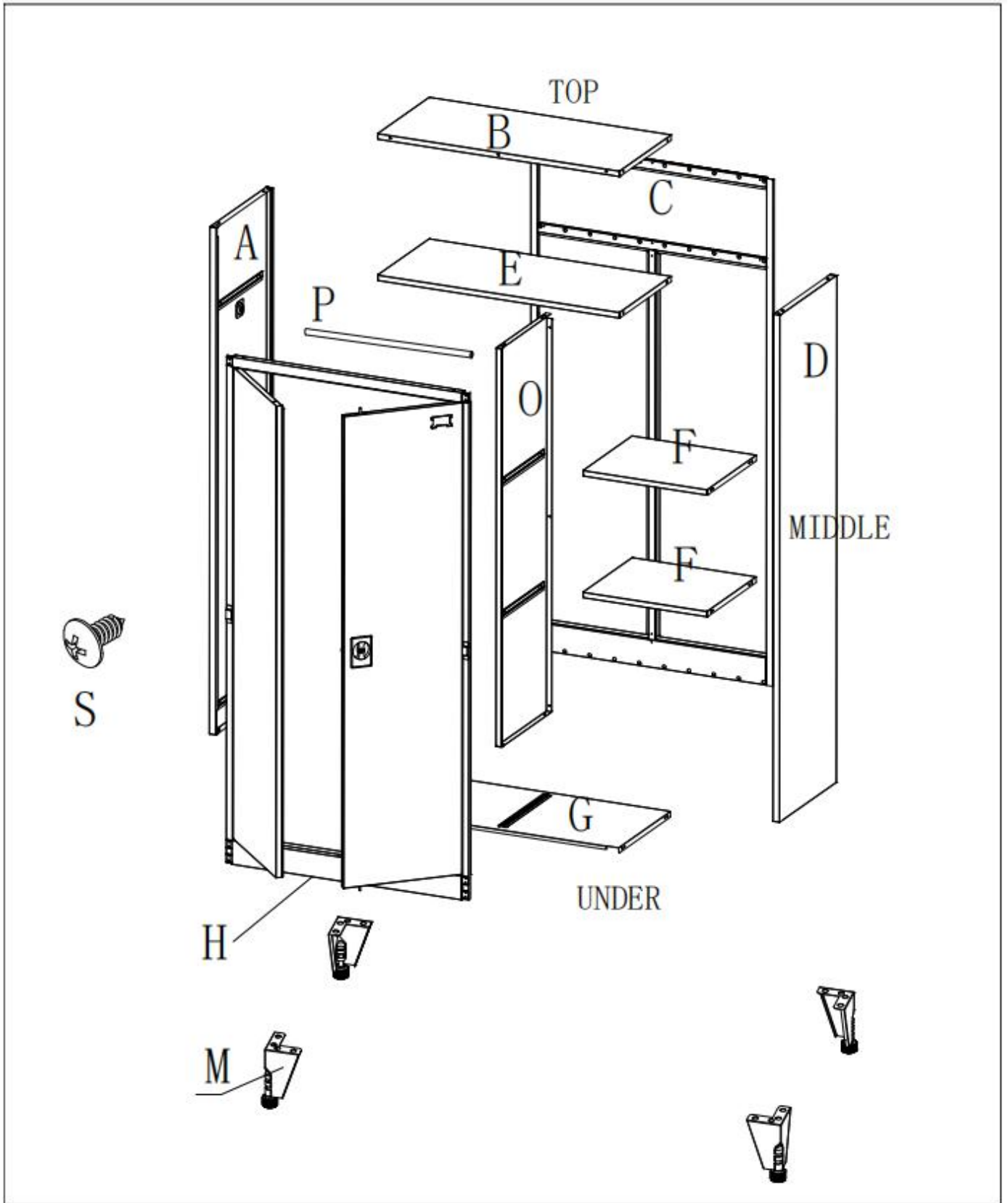

Bill of Material:

No.	Size(mm)	Quantity(pc)
TOP		
B	410*897	x1
MIDDLE		
A	450*1800	x1
D	450*1800	x1
C	898*1798	x1
H	898*1800	x1
E	409*897	x1
F	460.5*390	x2
O	1415.5*400	x1
P	439	x1
UNDER		
G	414*897	x1
M	60*60*110	x4
ANNEX		
S		x35

