

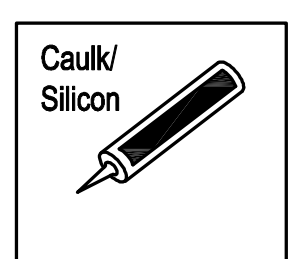

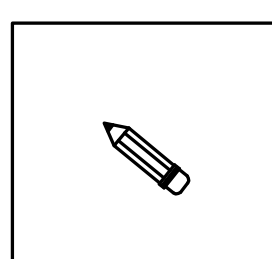

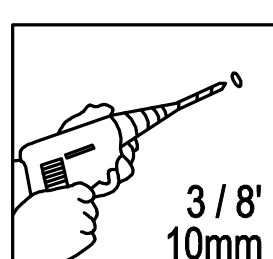

# CICI M-A

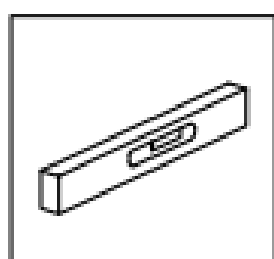
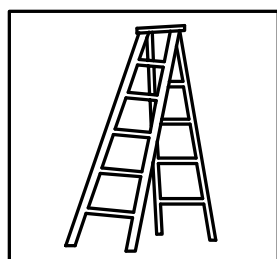
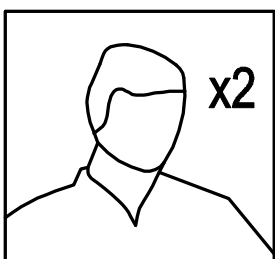
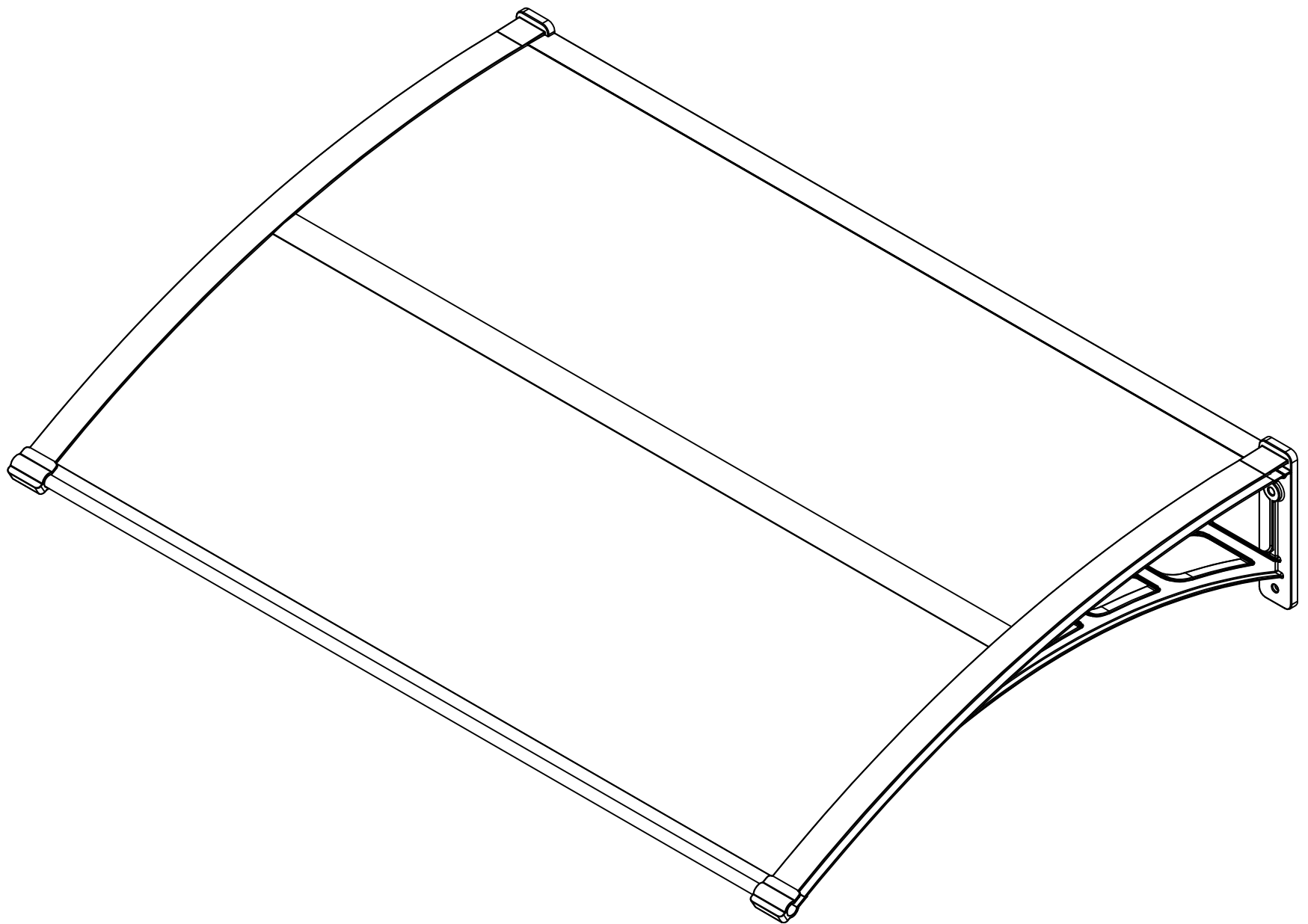
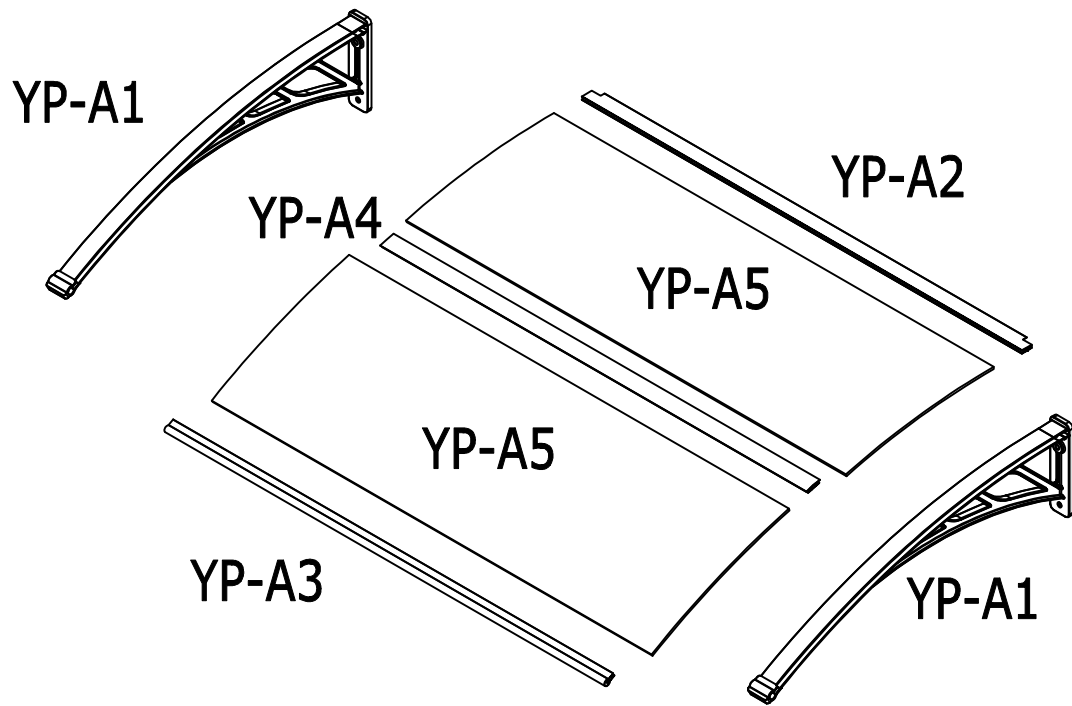

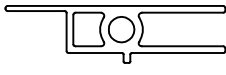

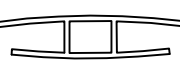
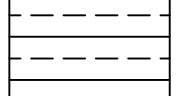
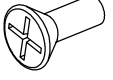
YP-A1		800mm	x2	1/1
YP-A2		946mm	x1	1/1
YP-A3		946mm	x1	1/1
YP-A4		910mm	x1	1/1
YP-A5		946X393mm	x2	1/1
YP-A6		M5X16mm	x4	1/1
YP-A7		ST8X60mm	x4	1/1
YP-A8			x4	1/1
			x1	1/1

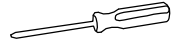
1. Αφαιρέστε περίπου 5 εκατοστά ταινίας από κάθε πλευρά πριν την συναρμολόγηση. Αφού πραγματοποιηθεί η συναρμολόγηση, αφαιρέστε εντελώς την υπόλοιπη ταινία.
2. Η πλευρά με την λευκή oral ταινία, έχει προστασία UV και πρέπει να τοποθετηθεί στην άνω πλευρά. Δηλαδή, στην πλευρά που έχει άμεση επαφή με τον Ήλιο.

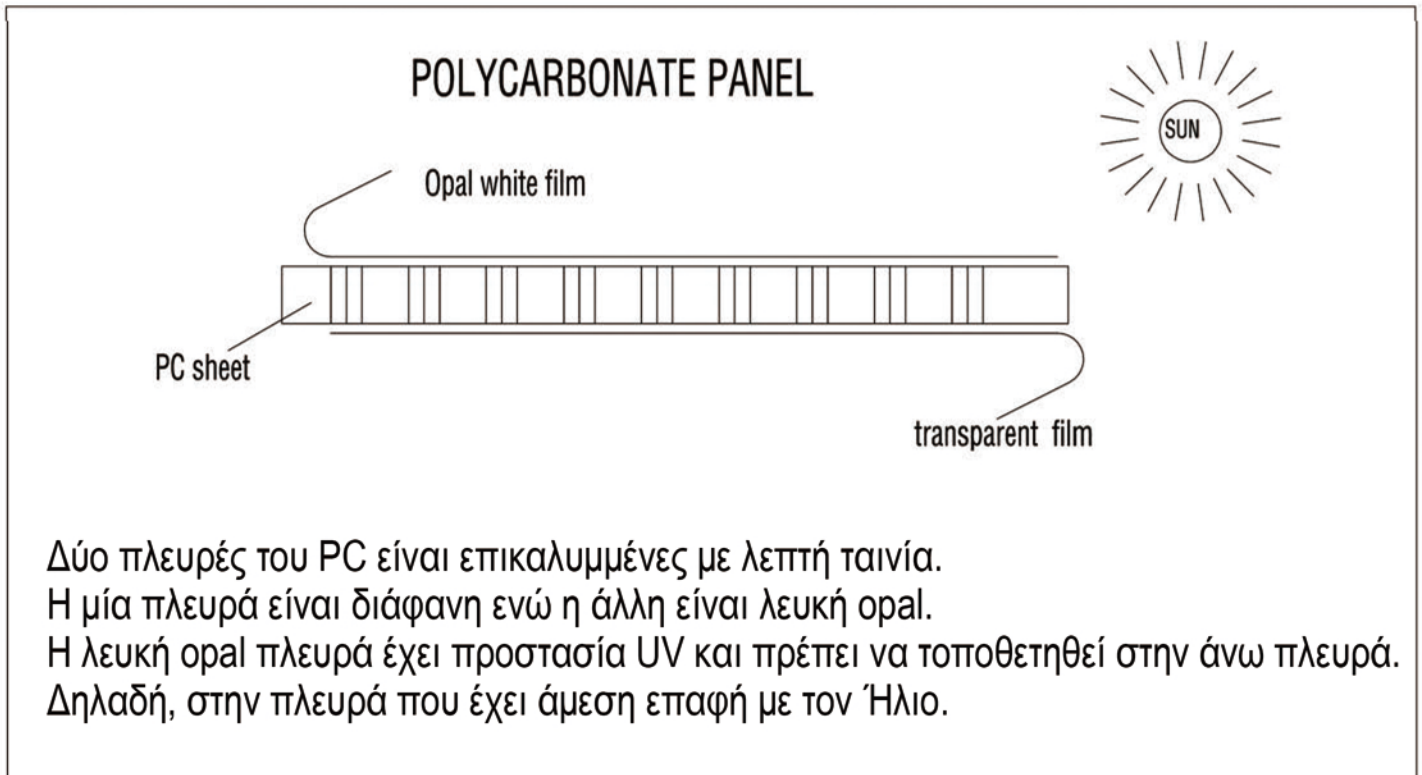

## Συμβουλή:

Μπορείτε να τοποθετήσετε στρώση σιλικόνης ανάμεσα στον σκελετό και το πολυκαρβονικά πάνελ.

